

Comfort 220

Operator System for Garages

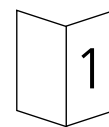

Installation and Operating Instructions

GB



A. Contents

A. Contents.....	3
B. Meaning of symbols	4 - 5
C. Important safety advice	6 - 7
D. Installation.....	8 - 16
01. Preparation	8
02. Required tools	8
03. Site requirements	8
04. Connect boom with operator unit.....	9
05. Mount suspension clamp to boom	9
06. Mount lintel joining plate	10
07. Unlock carriage	10
08. Garage door operator with up-and-over door.....	10 - 11
09. Garage door operator with sectional door	11 - 12
10. Garage door operator with retractable up-and-over door	12 - 13
11. Suspension of the operator system.....	14
12. Installation of bulb	14
13. Quick release	15 - 16
E. Hand transmitter	17 - 19
14. Hand transmitter - operation and accessories.....	17
15. Hand transmitter - programming:	18 - 19
F. Control unit connections	20 - 21
16. Module aerial.....	20
17. Connection of external control elements.....	21
G. Display functions and programming possibilities	22 - 47
18. Meaning of symbols.....	22
19. Summary on electronic control unit	22 - 23
20. Preparation of programming.....	23 - 24
21. Summary on display functions.....	25
22. Basic functions of the operator	26 - 27
23. Programming of basic level	28 - 32
24. Extended operator functions.....	33 - 43
25. Short programming instructions.....	44 - 45
26. Insert cover	46
27. Cabling plan	46
28. Wiring diagram Comfort 220	46 - 47
H. Test instructions.....	48 - 49
I. Error numbers.....	50
J. Initial operation and maintenance.....	51
K. Technical details	52
L. Index of illustrations.....	53
M. Manufacturer's declaration	54 - 55
N. Declaration of conformity.....	56 - 57
O. Supply package	

B. Meaning of symbols

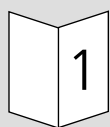

Text book

The instructions comprise two documents, one picture book and one text book.

This sign marks the text part.

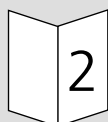

Picture book

The instructions comprise two documents, one picture book and one text book.

This sign marks the picture part.



Caution! Danger of personal injuries!

Here follow important safety advices, which have to be observed by all means to avoid danger of personal injuries!



Attention! Danger of material damage!

Here follow important safety advices, which have to be observed by all means to avoid material damages!



Functional check:





















After mounting and programming of most of the operating elements the function of the control unit can be tested. This is very useful to find out any error immediately and to save time when looking for errors.



Advice / tip

B. Meaning of symbols

Symbols of control unit, operator etc.:

	Operation, voltage		rpm sensor
	Impulse		To control unit
	Malfunction		Cable slack device
	End position OPEN		Connection lead
	End position CLOSED		Wicket door switch
	Power limit		Automatic timer
	STOP		Lighting
	External control elements		
	Electronic aerial		
	Photocell		
	Transmitter (Optosensor, photocell)		
	Receiver (Optosensor, photocell)		
	Closing edge safety device		

C. Important safety advice

Installation and initial operation of this operator may only be carried out by qualified and trained specialist personnel. Qualified and trained specialist personnel in the sense of this description are persons who have been trained and are supervised sufficiently by electricians and therefore are able to recognize the special hazards arising from electricity. Moreover they need to have the following qualifications corresponding to the respective work to be done, especially:

- Knowledge of the relevant electro-technical regulations,
- Training in use and maintenance of necessary safety equipment.



Caution!

Before installation of the operator:

- Remove all cables or chains that are not necessary.
- Put all devices, which are not necessary after the installation of the operator, out of operation.
- Test the mechanic situation of the door and check whether it is balanced and can be opened and closed correctly.



Caution!

Before starting cabling works please disconnect the operator by all means from power supply and keep a safety time of 10 sec.

Only after this time period has expired, the operator is without voltage!

- Observe local safety regulations!
- Always lay mains and control cables separately!
Control voltage 24 V DC.



Caution!

Before initial operations of the control unit please make sure that there are neither persons nor objects in the operation range of the door, as for some settings the door has to be moved!

C. Important safety advice

- All impulse and control devices (e.g. radio code keypad) that are fixed to the wall have to be mounted in view of the door, but in a safe distance to the movable parts of the door. The min. mounting height of 1,5 m has to be kept.
- All existing emergency command devices have to be tested before initial operation.
- The operator may only be mounted when the door is closed!
- Before initial operation the operators of the door system or their representatives have to be made familiar with the use of the system.
- The warning signs against trapping that are enclosed in the operator package have to be stuck permanently to a well visible place.
- After the installation please make sure that no parts of the door project neither to public sidewalks nor streets.



Caution!

In case these warnings are ignored, personal injuries and material damages may occur



Advice!

To avoid installation errors and damages to the door and operator, please follow by all means the mounting steps of these installation instructions!

Please keep these installation instructions for further reference, they contain important information regarding operational checks and maintenance works.

D. Installation

1 Preparation

- Unpack the boom and the motor unit and keep it ready for mounting.

2 Required tools

Combination wrench SW 10
Combination wrench SW 13
Socket wrench SW 8
Socket wrench SW 10
Socket wrench SW 13
Screw driver, size 5
Screw driver, size 8
Phillips Screw driver, size 2

Masonry drill \varnothing 6 mm
Masonry drill \varnothing 10 mm
Metal drill \varnothing 5 mm
Pliers
Hack saw
Electric drill
Electric drill



Attention!

Before drilling, cover the motor unit with foil or cardboard.
Drilling dust and chippings can lead to malfunctions.

3 Site requirements

- Please suspend the motor unit together with the boom in such a way, that the upper door edge lies approx. 10 mm below the downward horizontal boom edge- measured at the highest point of the opening course (see points 8, 9 and 10).
- Mount the unit to the ceiling according to the site requirements.
Please observe as well the indicated measurements for wall plug drilling.

D. Installation

4 Connect boom with the operator unit

- Push the adapter sleeve (A) to the stop onto the fine toothed gear shaft (fig. D.3).

If you turn the operator unit by 90°, the installation depth is lessened by 150 mm. For this the reference point switch (B) has to be turned as well to the foreseen position (fig. D.4).

- Put the boom in its right position to the adapter sleeve.
- Align the boom laterally.
- Push the boom onto the operator unit using slight pressure (fig. D.5).



Attention!

Do not use force!

If the boom is aligned parallel to the surface of the operator unit, a short pull on the carriage is sufficient to lower the boom onto the operator unit without force.

- Screw the boom to the operator unit using two clamp brackets (C) and four hex screws SW 8 (D) (fig. D.6).

5 Mount suspension clamp to boom

- Mount the suspension clamp to the boom (for function and position of the suspension clamp please look up point 3).

D. Installation

6 Mount the lintel joining plate

- To protect the pull element, which is integrated in the boom (chain or toothed drive belt), against unauthorized and forced dismantling from the outside (break-in), push the red securing sleeve (D) over screw (E) (fig. D.8).
- Then connect the lintel joining plate (A) and the boom end piece (B) with bolt (C) (fig. D.9).

7 Unlock the carriage

- Push the red release pin (B) to the stop into the red opening of the carriage (fig. D.10).
- Pull the cable (A) (fig. D.12).
- The carriage is now unlocked and can be slid freely in the boom and connected to the door.
- For further information regarding the carriage please look up point 13.

8 Garage door operator with up-and-over door

- Screw the lintel joining plate (A) together with the boom to the top frame, lintel or ceiling, so that the upper edge of the door leaf lies approx. 10 mm below the downward edge of the horizontal boom - measured at the highest point of the opening course (see as well point 3).
- Put the operator unit onto a trestle or another suitable object until it is fixed later to the ceiling.

D. Installation

- Connect two door link brackets (B) to the door connector (C).
- Screw this to the centre of the upper edge of the door leaf using 4 screws (drill \varnothing 5 mm).
- Insert the door link (D) together with the bolt (F) into the carriage (E).
- Fix it with 2 screws.
- Connect the door link and the door link bracket.



Advice!

Remove the door locks or put them out of function!

9 Garage door operator with sectional door

- Screw the lintel joining plate (A) with boom to the lintel or ceiling, so that the upper lamella of the door lies approx. 10 mm below the horizontal downward boom edge - measured from the highest point of the opening course (see as well point 3).
- Put the motor unit on a trestle or another suitable object until it is fixed later to the ceiling.
- Join two door link brackets (B) to the door connector (C).
- Screw this to the centre of the upper edge of the door leaf using 4 screws (drill \varnothing 5 mm).

If necessary, the motor unit can be installed 200 mm off-centre.

- For wooden sectional doors please use wood-screws \varnothing 5 x 35 mm (drill \varnothing 3 mm).
- Turn two self-tapping screws (D) so far into the door connector, until the points of the screws are in front of the lamella.

D. Installation

- Insert the door link (E) with bolt (G) into the carriage (F).
- Fix it with 2 screws.
- Connect door link and door link bracket.



Advice!

Remove the door locks or put them out of operation!



Attention!

In case the upper door lamella does **not** contain any stiffening plates or reinforcement straps (e.g. with one-wall doors): Use additionally door connector attachment Special 111, Art.-No. 47 574 (not part of the supply package, compare Fig. D 15).

In the other case please only use the door connector elements, because there is enough stability due to the stiffening.

10 Garage door operator for retractable up-and-over door

Required accessories:

- Adapter arm Special 102, Art.-No. 563 828
- Photocell Special 613, Art.-No. 153 550
- Photocell Special 613, Art.-No. 152 675
- 2-wire photocell, Art.-No. 47 816

These are not part of the supply package Comfort 220.



Advice!

Remove the door locks or put them out of operation!

D. Installation

- Screw the lintel joining plate (A) with boom to the top door frame, lintel or ceiling, so that the upper edge of the door leaf lies approx. 10 mm below the horizontal downward edge of boom - measured from the highest point of the opening course (see as well point 3) (fig. D.16).
- Put the motor unit on a trestle or another suitable object until it is fixed later to the ceiling.

Fitting the adapter arm:

- Screw the support bracket (B) to the upper door edge using 6 self-tapping screws (Drill \varnothing 5 mm) (fig. D.17).
- Centre of support bracket equals to the centre of boom.
- Put adapter arm (C) into support bracket (B) (fig. D.18).
- Screw it to the door cross strut (E) using two angle plates (D) (fig. D.18).

Drill \varnothing 5 mm in the door cross strut (4x)

Drill \varnothing 7 mm in the adapter arm (2x)

- Screw the angle plates to the adapter arm using two screws M6 x 10 and hexagon nuts.
- Insert linking bar (G) with bolt (J) into the carriage (F) (fig. D.19).
- Fix it with 2 screws.
- Open door fully
- Connect linking bar (G) with the adapter arm (C) (fig. D.19).
- Observe the indicated measurements.

While lowering the boom and by extending the linking bar the door opening is enlarged. The linking bar may only be extended so far that the inner pressure rolls (H) do not touch the fixing screws (I).

D. Installation

11 Suspension of the operator system

Suspension of motor unit

- Fix 1 support plate (A) above the motor unit (see as well point 3).
- Bend the plate according to site requirements.

Suspension of boom

- Push 1 support plate (A) through suspension clamp (B) and bend projecting parts.
- Positioning of the suspension of boom (see as well point 3).

12 Installation of the bulb



Attention!

Please disconnect by all means the unit from power supply before you change the bulb.

- Turn in a bulb E14 (max. 40 W).
- Clip in the lamp cover.
- Turn in the securing screw.

After given impulse the bulb is on for approx. 3 min.



Advice!

Bulbs are not covered by warranty.

D. Installation

13 Quick release



Attention!

Actuating the quick release may lead to uncontrolled movements of the door:

- in case the door springs are weak or broken.
- in case the door is not balanced.

When disengaged, the door may only be moved in a moderate speed!

When the door is opened by hand, the carriage may collide with the clamp strap of the suspension and with the motor unit.

GB

- Limit the door travel in open direction by means of construction works.
- Install the pull cord of the quick release in min. 1,8 m height.
- Attach the sign 'Instructions to use the pull cord of the quick release' to the pull cord.

D. Installation



Operational check:

After the operator has been mounted, the following tests have to be carried out:

- In 'close' direction the door runs against an obstacle of 50 mm that lies on the floor:
 - > The door has to reverse.

For operators for doors with openings in the door wing (diameter of the opening > 50 mm):

- A load of 20 kg is put to the middle of the bottom door edge:
 - > The door stops as soon as the open command is given.

Separate door from operator

- Pull the cable (A) downward to the stop in order to separate the door from the operator (Fig. D.22).

Connect door and operator again

- Push the red release pin (B) back in the direction of the arrow (D.24).
- Start the door operator.

The symbols on the downward side of the carriage show the actual situation:

The door is separated from the operator.

->The front edge of the movable slide element (C) is above the arrow of the symbol 'lock open' (fig. D.23).

The door is connected to the operator or will be connected automatically after the next door travel.

->The front edge of the movable slide element (C) is above the arrow of the symbol 'lock closed' (fig. D.24).

E. Hand transmitter

14 Hand transmitter - Operation and accessories

- A Battery - transmission control light
- B Operating buttons
- C Battery cover
- D Battery 3V CR 2032
- E Coding plug

- Please open the cover to change or insert the battery.
Observe right poling when changing the battery (fig. E.2).



Caution!

- Only operate the hand transmitter after you have made sure that there are neither persons nor objects in the operating range of the door.
- Children are not allowed to play with hand transmitters!



Advice!

Batteries are excluded from warranty.

Fixing accessories for hand transmitter:

Attachment clip, suitable to fix the hand transmitter to a visor in the car (fig. E.3).

E. Hand transmitter

15 Hand transmitter - Programming:

Learn coding (if necessary)

This function is meant to transmit a code from an existing hand transmitter to an additional hand transmitter (fig. E.4).



Advice!

Both sides of the plug connections can be used in an identical way.



Attention!

When actuating the hand transmitter, the door may be started!

Step 1:

- Connect both transmitters via the enclosed coding plug.

Step 2:

- Actuate the existing transmitter and hold the button. The LED in the transmitter is glowing.

Step 3:

- Actuate the desired button on the new hand transmitter and still hold the button of the existing transmitter.

After 1 - 2 sec. the LED on the new transmitter is on permanently.

The programming is terminated.

The new hand transmitter has now taken over the coding of the existing hand transmitter.

- Take out the coding plug.

E. Hand transmitter



Advice!

For multi-channel transmitters this procedure has to be carried out separately for every single button.

GB

Change coding

It is possible to change the coding of the remote control, in case a hand transmitter has gone lost. For this insert the coding plug into the hand transmitter that has to be re-programmed (fig. E.5).

Step 4:

- Insert the coding plug into the hand transmitter
- Short-circuit one of the outer pins of the coding plug with the centre lead (e.g. by means of a screwdriver).
- Actuate the desired button on the hand transmitter. The integrated random program generates a new code. The LED is flashing quickly.

As soon as the LED on the hand transmitter is on permanently, release the button of the hand transmitter and remove the coding plug.



Advice!

After a new coding of the hand transmitter the garage door operator has to be re-programmed to the new code, because the old code is lost irrevocably.



Advice!

For multi-channel transmitters this procedure has to be carried out separately for every single button.

F. Control unit connections

16 Module aerial

Protection category: only for dry buildings

- A Module aerial
- B Holder for aerial

- Insert the module aerial into the holder on the operator unit.



Advice:

Due to the digital safety encryption the operating range may vary. If necessary, the module aerial can be installed outside the building in order to achieve a larger operating range. For this an extension kit, protection category IP 65, is required (not part of the supply package).

F. Control unit connections

17 Connection of external control elements

- A Connection lead X 10 for control elements (Marantec system cabling),
B Connection terminals for control elements on building
- 1 = GND
 - 2 = Impulse
 - 3 = + 24 V DC max. 50 mA
 - 70 = GND
 - 71 = 2-wire system photocell (Art.-No. 47 816)
- C Control unit
D Short-circuit plug
E Socket X 20 (connection for longer module aerial IP 65)

GB



Attention!





Do not connect the short-circuit plug (D) to the socket (E)!

- Before a connection with system cabling please remove the short-circuit plug (D) (fig. F.2).
(e.g.: interior button or key switch outside;
not part of the Marantec supply package).

Please connect control elements on site only to the specially designated connection terminals (B). (fig. F.3).

G. Display functions and programming possibilities

18 Meaning of symbols:

-  LED off
-  LED on
-  LED flashing slowly
-  LED flashing quickly

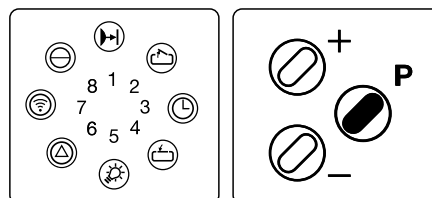

19 Summary on electronic control unit

- A Sign for external photocell
- B Sign for end position open / door opened
 - is on, as soon as the end position 'door open' is reached
- C Sign for end position close / door closed
 - is on, as soon as the end position 'door closed' is reached.
- D Sign for malfunction
 - is flashing in case of malfunctionSign for power limit:
 - LED 2 and 6 are flashing: power limit OPEN
 - LED 2 and 4 are flashing: power limit CLOSE
- E Sign for programming remote control
 - is on when button is actuated
 - is flashing on receipt of valid signal from hand transmitter
- F Programming button A / Test button 'OPEN'
- G Programming button B / Test button 'CLOSE'
- H Programming button C
(Programming mode, menu selection / save programming)
- I Display for voltage
 - is on at voltage
 - goes out for one second if motor stops

G. Display functions and programming possibilities

- N Connection terminals for external impulse button, 2-wire system photocell (Art.-No. 47 816)
- O Socket for 'external control elements'
- P Socket for 'electronic aerial', 'system photocell'

GB

Error messages



Advice:

To determine the error number add the figures of the irregularly flashing LED's.

See as well point I 'error numbers'.

In case of a malfunction the control light MALFUNCTION (D) is flashing.

- Shortly press button  .

The current error number is displayed by irregularly flashing LED's (e.g. error 7).

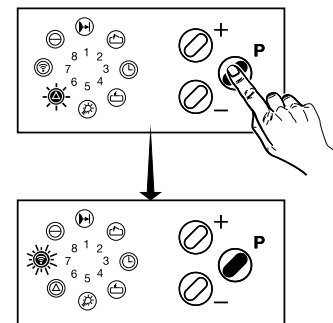

20 Preparation for programming

- The operator has to be mounted ready for operation.
- The door is not yet closed completely.
- If there is a driveway photocell, it should be connected!



Advice:

If the photocell / photocells are correctly mounted and aligned, the function 'photocell' is recognized automatically during programming!

G. Display functions and programming possibilities

- Remove the motor cover.
- Stick the enclosed sticker 'short programming instructions' inside the cover.
- Before programming the operator, insert a battery into your hand transmitter.

Programming is carried out with the three buttons (Ⓢ, ⊕ or ⊖).



Advice:

The programming is cancelled if none of the three buttons (Ⓢ, ⊕, ⊖) is actuated during a time period of more than 120 sec. All functions saved before with button Ⓢ remain unchanged.

When programming is cancelled, LED 6 is flashing.

After shortly pressing button Ⓢ the error message 7 is displayed.



Attention!

The operator has **two** programming levels.

For normal operation of the operator you only program the end positions and the remote control in the 1st programming level.

Button Ⓢ must not be pressed longer than 10 sec. because otherwise some important parameters set by factory will be changed.

Changes in the 2nd programming level may only be carried out by specialists.

G. Display functions and programming possibilities

21 Summary on display functions







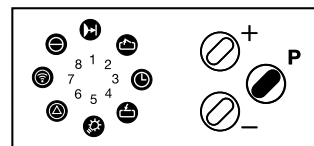





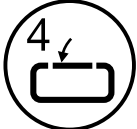

During normal operation the display shows following door situations:

Display functions

After having switched on the power supply the control unit carries out a self-test (for approx. 2 sec. all LED's are on).

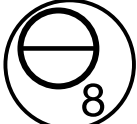

Display of door situations:

-   Door in end position OPEN
-   Door in end position CLOSED
-   Door passes the reference point
-   Malfunction, current error message
-   Remote control is actuated
-   Button is actuated
-   Operating voltage

G. Display functions and programming possibilities

22 Basic functions of the operator

Programming sequence:

- Press button $\text{\textcircled{P}}$ for approx. 2 sec. and release it.

The control unit changes from operating state to the programming state of the basic functions.

LED 2 flashes and all others are on.

Changes in programming menu are carried out by pressing the buttons \oplus or \ominus . The current values are saved with button $\text{\textcircled{P}}$.

The control unit changes to the next programming menu.

If the button $\text{\textcircled{P}}$ is pressed and no changes via buttons \oplus or \ominus have been carried out, the respective programming menu is skipped and the settings remain unchanged.

After the last programming menu the programming of the operator basic functions is terminated, recognizable by all LED's going off in the sequence 8 - 1.

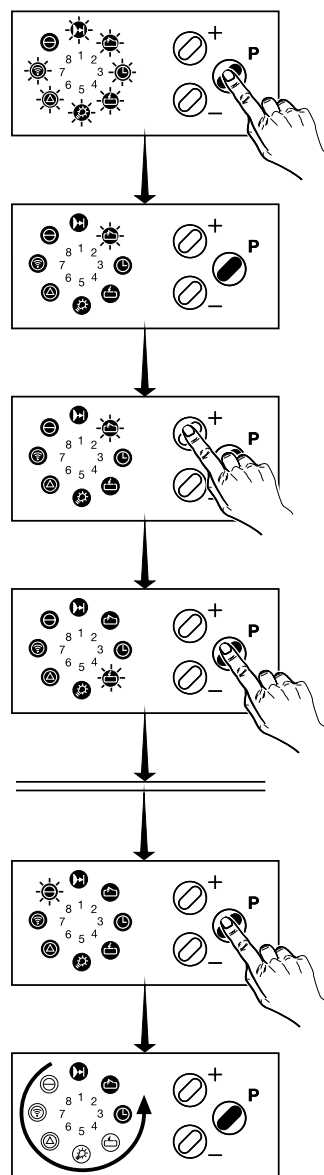

G. Display functions and programming possibilities

General advice regarding the programming of control unit



Advice regarding programming:

If the control unit is in programming mode and none of the three programming buttons (\oplus , \ominus , \textcircled{P}) is pressed during a time period of 120 sec., the programming procedure is cancelled and the control unit changes to operating mode).

GB



Advice:

The end positions can only be programmed if there is a valid reference point. For this travel the door electrically once to open or close position.

Display of the reference point



The operator **passes** the reference point sensor:

- LED 5 shortly glows up.

Set the positions



Advice:

The control unit works without press-and-hold!

- Press button \oplus or \ominus to travel the door to the desired door position.

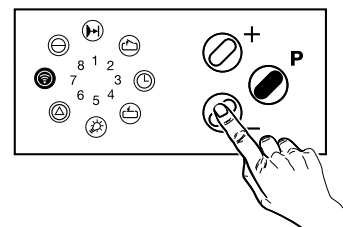
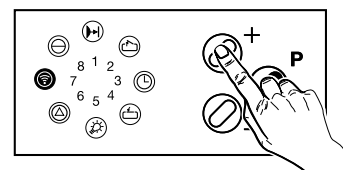

G. Display functions and programming possibilities

23 Programming of the basic level

1. Programming of 'end position OPEN'

- Press button \textcircled{P} for approx. 2 sec. and then release it.

LED 2 is flashing and all others are on.

- Press button \oplus to set the end position OPEN. Carry out the fine adjustment with button \oplus or \ominus .



Advice:

The reference point has to be passed 1x!

- Save the end positions with button \textcircled{P} .

The control unit changes automatically to the programming of 'end position CLOSE'.

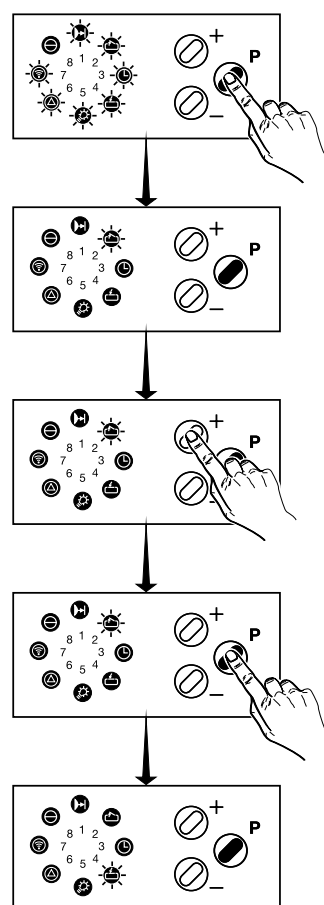
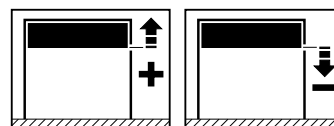

G. Display functions and programming possibilities

2. Programming of the 'end position CLOSE'

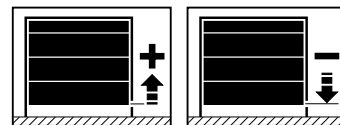

LED 4 is flashing and all others are on:

- Press button \ominus to set the end position CLOSE. Carry out the fine adjustment with button \oplus or \ominus .



Advice:

The reference point has to be passed 1x!

- Save the end position with button \oplus .

The control unit changes automatically to the programming of 'remote control'.

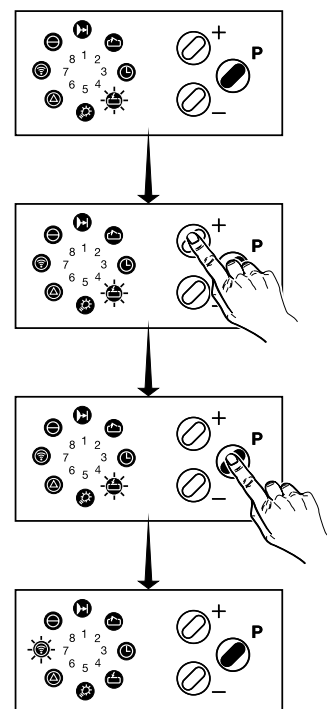



GB

G. Display functions and programming possibilities

3. Programming of remote control

LED 7 is flashing and all others are on.

- Actuate the respective button on the hand transmitter until LED 7 is flashing quickly. The control unit has now learned the code of the hand transmitter.
- Press button  to save the code of the remote control.
- Press again button  to terminate the programming.

The control unit is now in operating mode (in case of power failure all settings remain unchanged).

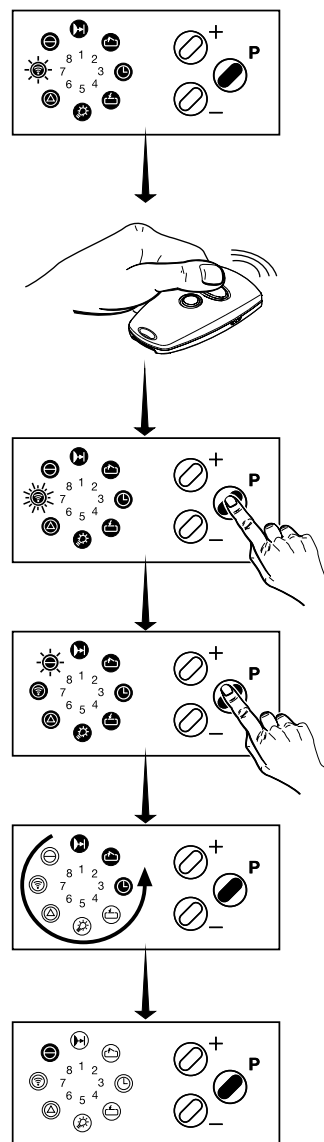

G. Display functions and programming possibilities



Advice:

All menus can be reset by a RESET function to the original values set by factory. For this carry out the steps described in the point 'Programming of the basic level'. After the remote control has been saved, the control unit changes to the programming menu 'RESET factory settings'.

GB

4. Programming 'RESET factory settings'

LED 8 is flashing and all others are on:

- Press button \oplus or \ominus to go to function 'reset'.

LED 1 is flashing quickly; function '**no reset**' is selected.

All programmed values remain unchanged.

LED 1 is on; function '**reset**' is selected.

All programmed values are overwritten by the values set from factory.

- Press button \textcircled{P} to confirm reset function.

When 'reset' has been selected, the control unit carries out a new start, recognizable by all LED's glowing for 2 sec.

The control unit is now in operation mode (settings from factory), in case of power failure all settings remain unchanged.

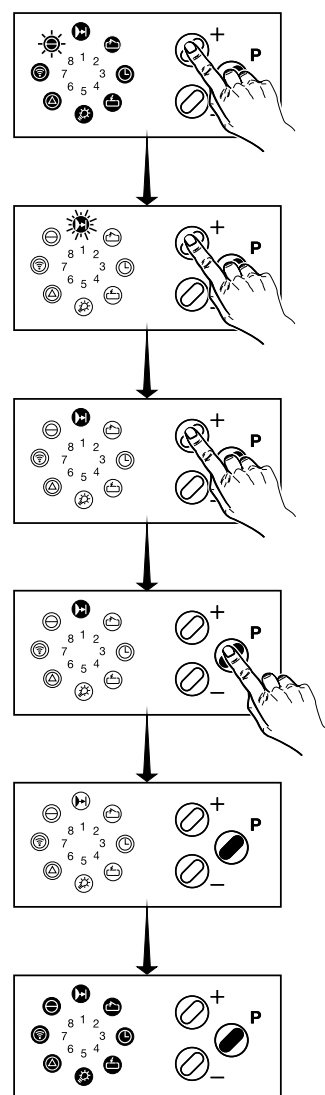

G. Display functions and programming possibilities

Learning of drive power:



Attention!

If the operator cuts out during the test run and LED 8 and LED 2 are flashing quickly (error number 10 / automatic cut-out):

- Set the automatic cut-out
- For this look up point 2:
Programming 2nd level, point 2 + 3.

- Travel the operator (with door engaged) completely and without interruption two times from door position 'DOOR CLOSED' to door position 'DOOR OPENED' and vice versa.

During these two learning travels the operator determines the maximum push and pull force which is required to move the door. After two further complete door travels the operator is definitely ready for operation.

These settings remain unchanged even if power supply is interrupted, but they can, nevertheless, if necessary, be changed as described before.

Test:

- Press button \oplus .
→ The door must open and travel to the 'door open' position, that has been set by you.
- Press button \ominus .
→ The door must close and travel to the 'door closed' position, that has been set by you.
- Shortly press the button on your hand transmitter.
→ The operator moves the door to 'OPEN' resp. 'CLOSE' direction.
- Press the button on your hand transmitter again during the operator run.
→ The operator must stop

The next push onto the button causes the operator to run in the opposite direction.

24 Extended operator functions (2nd programming level)



Advice:

The values for the automatic cut-out (= max. force) and learning power limit (= power curve) can be set manually in the 2nd programming level.

A setting should always be carried out as soon as a less sensitive setting has to be chosen due to door travel properties caused by site conditions, as otherwise the automatic cut-out or power limit would react and cause malfunctions.

In general you have to take care that the allowed operating forces according to EN 12445 and EN 12453 are not exceeded.

G. Display functions and programming possibilities



Advice:

Changes in the programming levels of the extended operator functions may only be carried out by specialists!

Explanation of the extended operator functions:

Functions	Explanation	Settings from factory
Menu 1: - programming external photocell	Setting whether the operator is run with or without photocell.	no photocell existing
Menu 2: - power limit OPEN	The sensitivity of power limit can be set in steps from 1 - 16.	step 5
Menu 3: - power limit CLOSE	The sensitivity of power limit can be set in steps from 1 - 16.	step 5
Menu 4: - offset learned power limit	The sensitivity of power limit can be set in steps from 2 - 16.	step 13
Menu 5: - operator speed	The speed the door is moved by the operator can be set	step 16 (max. speed)

G. Display functions and programming possibilities



1. Programming of external photocell

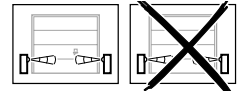

Advice:

Still hold the programming button P when LED 2 starts to flash after 2 sec. In order to come to the 2nd programming level, hold programming button P for further 8 sec. (LED 2 is then flashing quickly).

GB

- Press button P for more than 10 sec, until LED 2 flashes quickly.
- Release button P .
LED 1 flashes.
- Press button \oplus to make a connection of external photocells possible.
 - LED 1 is on:
Operation with system photocell
 - LED 1 is on, LED 2 is flashing:
Operation with 2-wire photocell
 - LED's 1 and 2 are on:
Operation with system and 2-wire photocell
- When pressing button \ominus the operator can be run without external photocell:
 - LED 1 is flashing.
- Save your setting with programming button P .

The control unit changes automatically to the programming procedure 'automatic cut-out OPEN'.

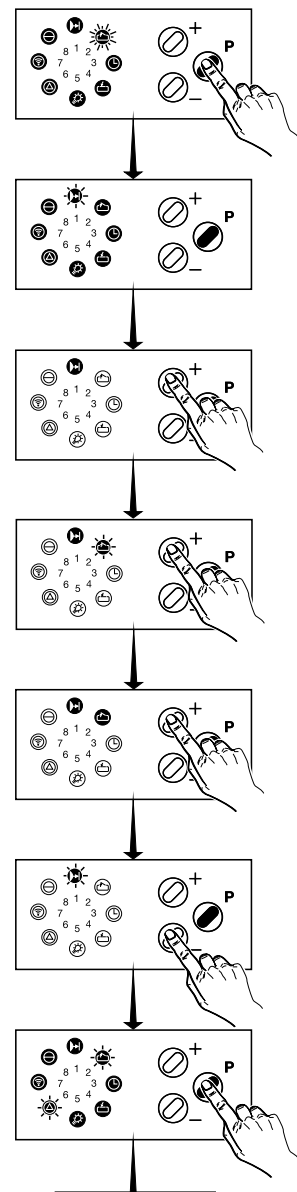

G. Display functions and programming possibilities



2. Programming 'automatic cut-out OPEN'



Attention!

The automatic cut-out is set automatically.
Only change it if necessary (error No. 10)

When increasing the set value the max. force in OPEN direction is increased and thus the sensitivity of the automatic cut-out is reduced.

Attention!

Always test the max. allowed operating forces according to EN 12445 and EN 12453!



Advice:

The setting of the automatic cut-out corresponds to the maximum power of the operator. At the first travel to OPEN or CLOSE direction after 'POWER ON' the automatic cut-out is effective according to the adjustment. For further travels the self-learned power, that is more sensitive, is effective. The automatic cut-out is still the upper limit of power.

G. Display functions and programming possibilities

LED's 2 and 6 are flashing.

- With button \oplus or \ominus the 'automatic cut-out' can be set in steps from 1 (most sensitive value) to 16 (according to table).
- Save your setting with programming button \textcircled{P} .

The control unit changes automatically to programming of 'automatic cut-out CLOSE'.

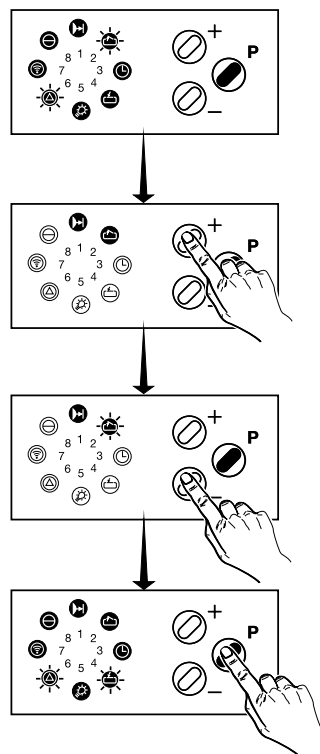

Advice!

When re-programming the end positions (1st programming level) the pull force is learned once more.

With new setting of the end positions the force values are determined automatically. Depending on the door travel properties increasing of the force values may be necessary.

G. Display functions and programming possibilities



3. Programming 'automatic cut-out CLOSE'

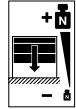

Attention!

The automatic cut-out is set automatically.
Only change it if necessary (error No. 10)

When increasing the set value the max. force in CLOSE direction is increased and thus the sensitivity of the automatic cut-out is reduced.

Attention!

Always test the max. allowed operating forces according to EN 12445 and EN 12453!



Advice:

The setting of the automatic cut-out corresponds to the maximum power of the operator. At the first travel to OPEN or CLOSE direction after 'POWER ON' the automatic cut-out is effective according to the adjustment. For further travels the self-learned power, that is more sensitive, is effective. The automatic cut-out is still the upper limit of power.

G. Display functions and programming possibilities

LED's 4 and 6 are flashing.

- With button \oplus or \ominus the 'automatic cut-out' can be set in steps from 1 (most sensitive value) to 16 (according to table).
- Save your setting with programming button \textcircled{P} .

The control unit changes automatically to programming 'offset learned power limit'.

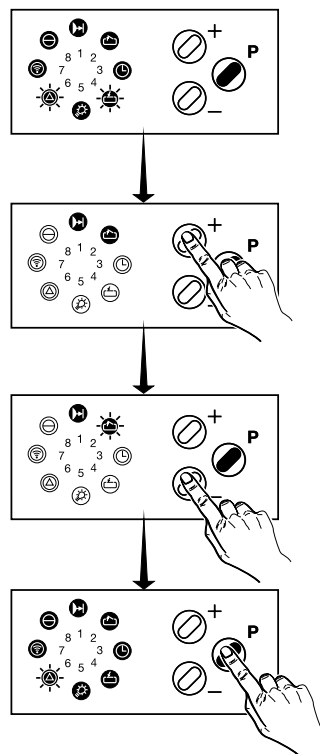

Advice!

When re-programming the end positions (1st programming level) the pull force is learned once more.

With new setting of the end positions the force values are determined automatically. Depending on the door travel properties increasing of the force values may be necessary.

G. Display functions and programming possibilities

4. Programming 'offset learned power limit'



Attention!

The learning power limit is set automatically.
Only change it if necessary (error No. 28)

When increasing the set value the offset in OPEN and CLOSE direction is increased and thus the sensitivity of the learning power limit is reduced.

Attention!

Always test the max. allowed operating forces according to EN 12445 and EN 12453!

LED 6 is flashing.

- With button ⊕ or ⊖ the 'offset learned power limit' can be set in steps from 2 (most sensitive value) to 16 (according to table).
- Save your setting with programming button ⊕.

The control unit changes automatically to the programming of 'operator speed'.

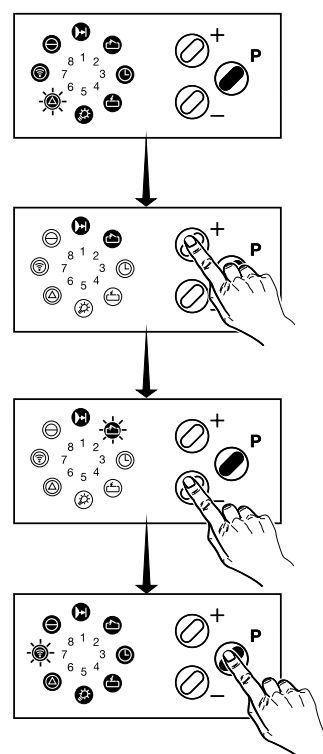

G. Display functions and programming possibilities

5. Programming of 'operator speed'

LED 7 is flashing.

- With button \oplus or \ominus the 'operator speed' can be set in steps from 7 (slowest) to 16 (according to table).
- Save your setting with programming button \textcircled{P} .

After the last programming level the programming of extended operator functions is terminated, recognizable by all LED's going out in sequence 8 - 1.

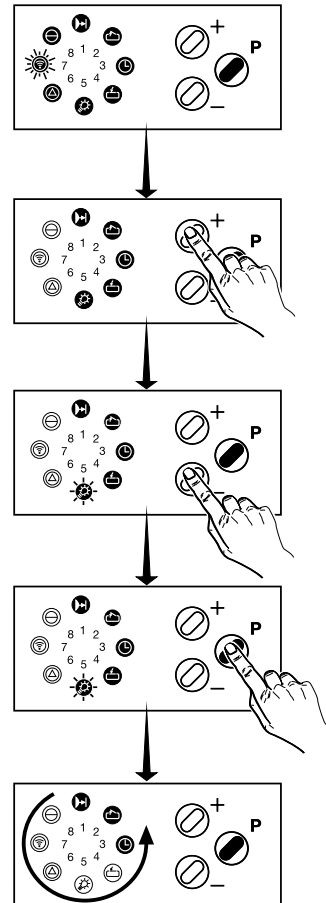

G. Display functions and programming possibilities

Adjustable values of the extended operator functions

← BUTTON ⊖							
	1	2	3	4	5	6	7
Menu 1: External photocell							
	operation without photocell	operation with system-photocell	operation with 2-wire photocell	operation with system and 2-wire photocell			
Menu 2: Automatic cut-out OPEN (sensitivity in steps)							
	1	2	3	4	5	6	7
Menu 3: Automatic cut-out CLOSE (sensitivity in steps)							
	1	2	3	4	5	6	7
Menu 4: Offset learned power limit (sensitivity in steps)							
	OFF	2	3	4	5	6	7
Menu 5: Operator speed							
	cannot be set	cannot be set	cannot be set	cannot be set	cannot be set	cannot be set	7

Legend:



LED off



LED flashes slowly



LED on



LED flashes quickly

G. Display functions and programming possibilities



Advice:

If an external driveway photocell is connected, the operator has to be re-programmed!

GB

BUTTON ⊕ →								
8	9	10	11	12	13	14	15	16
8	9	10	11	12	13	14	15	16
8	9	10	11	12	13	14	15	16
8	9	10	11	12	13	14	15	16
8	9	10	11	12	13	14	15	16

Settings from factory

not possible

G. Display functions and programming possibilities

25 Short programming instructions

Short programming instructions of the basic functions:

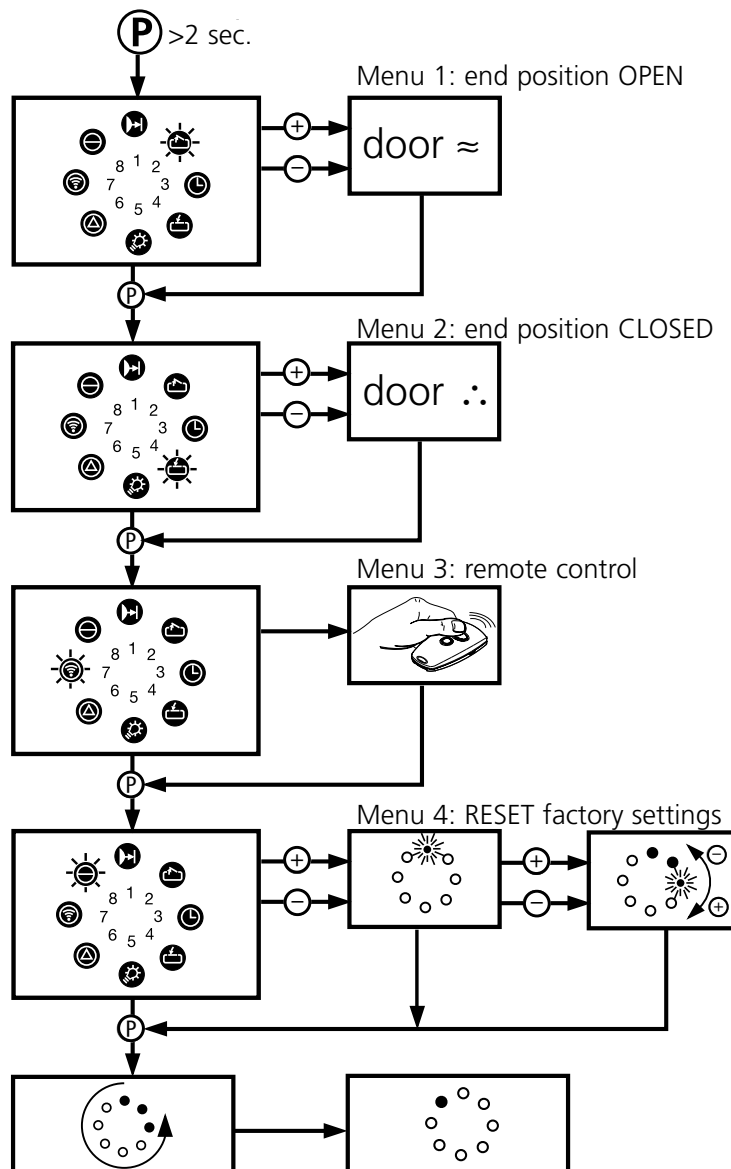

G. Display functions and programming possibilities

Short programming instructions of the extended operator functions:

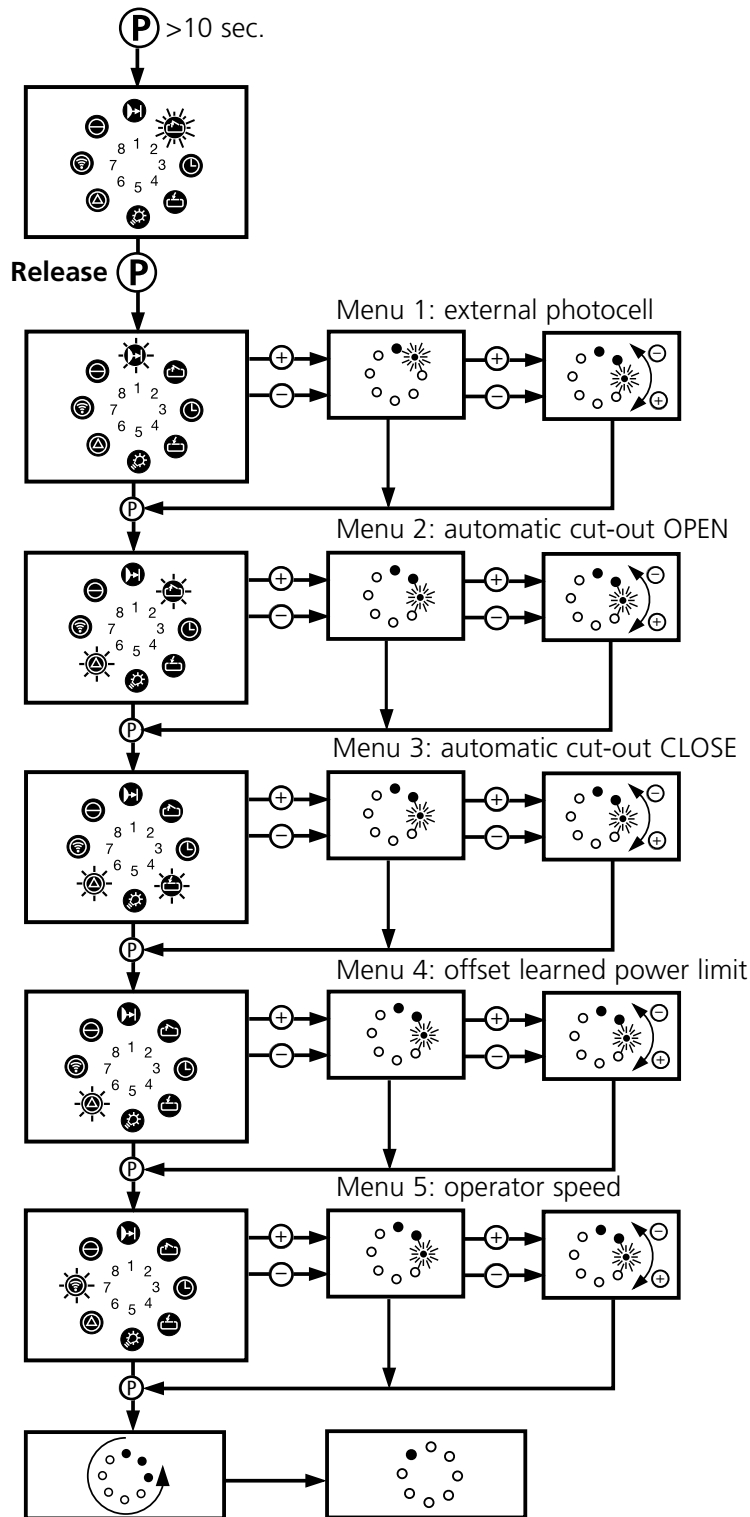

G. Display functions and programming possibilities

26 Insert cover

27 Cabling plan

- A Operator Comfort 220
- B Safety socket 230 V, 50 Hz
- C Module aerial
- D Control circuit board Comfort 220
- E Interior button with connection lead
(not part of the supply package Comfort 220)
- F Key switch (not part of the supply package Comfort 220)

28 Wiring diagram Comfort 220

- H4 Operator light
- M1 Motor
- S Main switch or button 'emergency OFF' (on building)
- S1b 'IMPULSE' button (on building)
- S22 Reference point sensor
- V1 rpm sensor
- X1 Safety socket (on building)
- X2 Mains plug
- X10 Socket for control elements
- XS10 Bedienelemente
- X3c Connection terminals 'IMPULSE' button /
'2-wire system photocell (Art.-No. 47 816)'
- X20 Socket 'system photocell'
- V20 System photocell
- W20 Module aerial

G. Display functions and programming possibilities



Attention!

Low voltage!

External voltage on the sockets X10, X20 or screw terminals X3c will destroy the whole electronics.



Attention!

Observe local safety regulations!

Lay power and control leads by all means separately.

H. Test instructions

Error	Error message	Cause for error
• Error	• Control light VOLTAGE does not light up.	<ul style="list-style-type: none"> • No voltage • Thermal overload protection in transformer is active. • Control unit defective
• No reaction on impulse	• Control light MALFUNCTION is flashing / error No. 36.	• Static current circuit (operating elements) is interrupted.
• Photocell	• Control light MALFUNCTION is flashing / error No. 6 or 15	<ul style="list-style-type: none"> • Photocell defective • Photocell interrupted
• Remote control	• Control light IMPULSE does not light up when giving impulse by hand transmitter.	<ul style="list-style-type: none"> • Electronic aerial not connected or wrong installation. • Wrong programming of hand transmitter coding. • Empty battery
• Power limit - max. power - learning power	• Control light MALFUNCTION is flashing / error No. 10 or 28	<ul style="list-style-type: none"> • Door is too sluggish or is blocked. • Power limit is set too sensitively.
• Door can only be opened.	• Control light MALFUNCTION is flashing / error No. 15.	• Photocell programmed but not connected.
• Operator only starts to run shortly.	• Control light MALFUNCTION is flashing / error No. 9.	<ul style="list-style-type: none"> • rpm sensor defective. • Door is too sluggish.

H. Test instructions

Remedies

- Check voltage.
- Check all fuses and plug connections to power.
- Have motor aggregate cooled down.
- Have control unit checked.
- Put short-circuit plug into the socket.
- Connect stop button.
- Remove obstacle.
- Have photocell checked.
- Connect aerial or align it again.
- Program coding again.
- Insert new battery (3V CR2032).
- Maintain door system (grease it or similar) or bring the door into a movable condition.
- Set power limit less sensitive.
- Increase offset learned power limit (2nd programming level/ Menu 4).
- Connect photocell or re-program the operator.
- Have the operator checked.
- Check door.

I. Error numbers

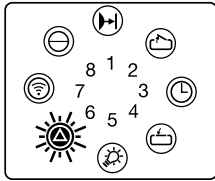

Error 6:
Photocell is active.

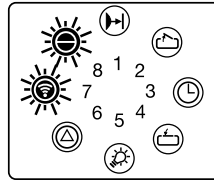

Error 15:
Testing photocell not OK.

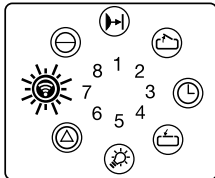

Error 7:
Programming cancelled.

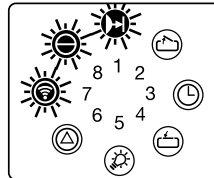

Error 16:
Testing power sensor not OK.

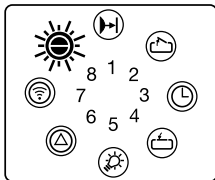

Error 8:
Reference point not OK.

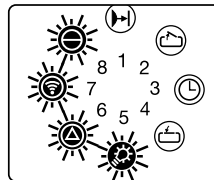

Error 26:
Voltage monitoring is active.

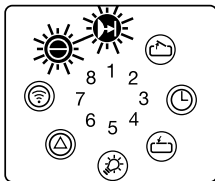

Error 9:
Rpm detection defective /
Anti-block device is active.

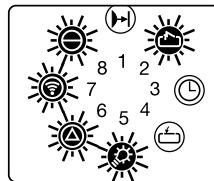

Error 28:
Learned power limit is active.

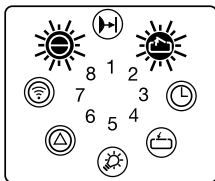

Error 10:
Power limit is active.

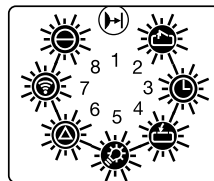

Error 35:
Electronics defective.

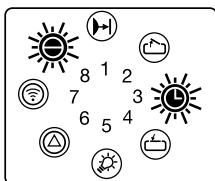

Error 11:
Excess travel stop
is active.

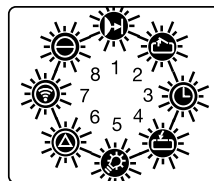

Error 36:
Static current circuit is
interrupted.

J. Initial operation and maintenance

Initial operation



Attention!

Power operated windows, doors and gates for industrial use have to be checked before initial operation or if necessary, but at least once a year by a specialist (with written documentation)!

GB

Maintenance instructions

Please observe the following points in order to guarantee a faultless function:

- Check the separate counterbalance of the door regularly.
The door has to be moved easily by hand if the operator is disengaged.
- The door system, especially cables, springs and fixing components have to be checked regularly for signs of wear, damages or for faulty balance.
- The function of automatic cut-out "open" and "close" has to be checked regularly.
- Test monthly, if the operator reverses when the door meets an obstacle of 50 mm that is lying on the floor.

Correct, if necessary, the adjustment of the reversion function and test it again, because a wrong adjustment could be dangerous.



Caution!

The door system must not be used during repair or adjustment works. A fault in the system or a wrongly balanced door may cause injuries.

K. Technical details

Garage door operator Comfort 220

Connected loads:

230 V

250 W (operation with lighting)

3,9 W (at standstill without lighting)

Door travel speed:

0,14 m/s with soft start and soft stop

Push and pull force:

500 N

Excess travel stop:

88 sec.

Lighting:

1x 40 W, E14,

goes off automatically after 180 sec.

Control voltage:

Low voltage below 24 V DC.

Automatic cut-out:

Electronic power limit through microprocessor and voltage sensor.

Anti-block system:

Through microprocessor and rpm sensor.

Device to prevent forced opening of door:

Through microprocessor and rpm-sensor.

Protection category:

Only for dry buildings.

L. Index of illustrations (Book of illustrations)

Fig. D.1:	Required tools	Fig. E.1:	Hand transmitter
Fig. D.2:	Site requirements	Fig. E.2:	Open hand transmitter / Insert battery
Fig. D.3:	Push on adapter sleeve	Fig. E.3:	Attachment clip for hand transmitter
Fig. D.4:	Turn operator unit	Fig. E.4:	Learn hand transmitter coding
Fig. D.5:	Boom on operator	Fig. E.5:	Change hand transmitter coding
Fig. D.6:	Screw boom to operator	Fig. F.1:	Electronic aerial
Fig. D.7:	Mount suspension clamp	Fig. F.2:	Connection of external control elements
Fig. D.8:	Mount securing sleeve	Fig. F.3:	Details external control elements
Fig. D.9:	Lintel joining plate at the boom end piece	Fig. G.1:	Summary on electronic control unit
Fig. D.10:	Release pin out of carriage	Fig. G.2:	Remove cover
Fig. D.11:	Release pin inside carriage	Fig. G.3:	Replace cover
Fig. D.12:	Release the carriage	Fig. G.4:	Cabling plan Comfort 220
Fig. D.13:	Operator with up-and-over door	Fig. G.5:	Wiring diagram Comfort 220
Fig. D.14:	Operator with sectional door	Fig. O.1:	Supply package-1
Fig. D.15:	Operator with heavy sectional door	Fig. O.2:	Supply package-2
Fig. D.16:	Operator with retractable up-and-over door		
Fig. D.17:	Fixing angle for adapter arm		
Fig. D.18:	Adapter arm at the door		
Fig. D.19:	Measurements of adapter arm		
Fig. D.20:	Suspension of operator system		
Fig. D.21:	Installation of bulb		
Fig. D.22:	Separate door from operator-1		
Fig. D.23:	Separate door from operator-2		
Fig. D.24:	Connect door with operator		

**Herstellererklärung
Manufacturer's Declaration
Déclaration du fabricant
Fabrikantenverklaring
Declaración del fabricante
Dichiarazione del produttore**

(D)

Hiermit erklären wir, daß das nachfolgend bezeichnete Produkt aufgrund seiner Konzipierung und Bauart sowie in der von uns in Verkehr gebrachten Ausführung den einschlägigen grundlegenden Sicherheits- und Gesundheitsanforderungen der EG-Richtlinie Elektromagnetische Verträglichkeit, der Maschinen-Richtlinie und der Niederspannungsrichtlinie entspricht.
Bei einer nicht mit uns abgestimmten Änderung der Produkte verliert diese Erklärung ihre Gültigkeit.

(GB)

We hereby declare that the product referred to below, with reference to its design, construction and to the version as marketed by us, conforms to the relevant safety and health requirements contained in the European Council Directives pertaining to electromagnetic compatibility, machines and low voltage.
This declaration becomes null and void in the event of modification or changes to the product not expressly agreed with us.

(F)

Par la présente, nous déclarons que le produit sous-mentionné correspond, de par sa conception et son type de construction, tout comme la version commercialisée, aux conditions fondamentales exigées pour la sécurité et la santé de la directive CE relative à la compatibilité électromagnétique, de la directive concernant les machines et de celle relative à la basse tension.
Cette déclaration perd toute validité en cas de modification des produits, effectuée sans notre accord.

(NL)

Hierbij verklaren wij dat het hierna genoemde product qua ontwerp en constructie alsmede de door ons op de markt gebrachte uitvoering voldoet aan de hiervoor geldende veiligheids- en gezondheidseisen conform de Europese richtlijnen t.w.: EMC-richtlijn, Machinerichtlijn en Laagspanningsrichtlijn.
Ingeval van wijzigingen aan onze producten die niet met ons afgestemd zijn, verliest deze verklaring haar geldigheid.

(E)

Por la presente declaramos que el producto indicado a continuación, en base a su concepción y tipo constructivo, así como en el acabado comercializado por nosotros, cumple con los requisitos básicos obligatorios sanitarios y de seguridad de la directiva de la CE sobre compatibilidad electromagnética, la Directiva de Maquinaria y la Directiva de Baja Tensión.
En caso de una modificación del producto no acordada con nosotros, esta declaración perderá su validez.

(I)

Con la presente dichiariamo che il prodotto di seguito descritto, in base alla sua progettazione e tipo e nella versione da noi messa in commercio, rispetta tutti i requisiti essenziali di sicurezza e sanitari che lo concernono previsti dalla direttiva CE sulla compatibilità elettromagnetica, dalla direttiva relativa alle macchine e dalla direttiva relativa alla bassa tensione.
In caso di modifica apportata senza nostra autorizzazione, la presente dichiarazione perde la propria validità.

**Produsenterklæring
Fabrikanterklæring
Декларация производителя
Δήλωση του κατασκευαστή
Declaração do Fabricante
制造商申明**

(N)

Herved erklærer vi at det i det følgende betegnede produktet på grunn av dets konsepsjon og konstruksjon i den versjonen som vi har brakt i handelen er i samsvar med de vedkommende grunnleggende krav til sikkerhet og helse i EF-direktivet Elektromagnetisk kompatibilitet, i Maskindirektivet og i Lavspenningsdirektivet.
Ved en endring av produktet som ikke er avstemt med oss, mister denne erklæringen sin gyldighet.

(DK)

Hermed erklærer vi, at efterfølgende opførte produkt på grund af dets concipering og konstruktion og i den udførelse, som vi har bragt i handelen, opfylder de vedtagne grundlæggende sikkerheds- og sundhedskrav ifølge EF-Direktivet om Elektro-magnetisk kompatibilitet, Maskindirektivet og Lavspændingsdirektivet.
Såfremt der foretages ændringer af produktet, der ikke er godkendt af os, bliver nærværende erklæring ugyldig.

(RUS)

настоящим объявляем, что указанная ниже продукция по своему проектированию и конструкции, а также по используемому нами типу изготовления соответствует действующим основополагающим требованиям по безопасности и охране здоровья директив ЕС по электромагнитной совместимости, оборудованию и технике низких напряжений. В случае производства несанкционированных производителем изменений в продукции, данная декларация считается недействительной.

(GR)

Με την παρούσα δηλώνουμε ότι το προϊόν που περιγράφεται παρακάτω, σύμφωνα με το σχεδιασμό και τον τύπο κατασκευής του, στο μοντέλο που κυκλοφορεί στο εμπόριο, πληρεί όλες τις βασικές απαιτήσεις ασφαλείας και υγιεινής που προβλέπουν η Οδηγία ΕΕ σχετικά με την ηλεκτρομαγνητική συμβατότητα, η αντίστοιχη Οδηγία μηχανημάτων και η Οδηγία χαμηλής τάσης. Σε περίπτωση τροποποίησης χωρίς την έγκρισή μας, η παρούσα δήλωση παύει να ισχύει.

(P)

Declaramos por este meio que o produto abaixo descrito corresponde, pela sua concepção e modelo, tal como no modelo por nós comercializado, às respectivas exigências básicas de segurança e de saúde da Directiva CE relativa a Tolerância Electromagnética, da Directiva relativa a Maquinaria e da Directiva sobre Baixa Tensão.
Em caso de qualquer tipo de alteração não previamente acordada com a nossa Empresa, a presente declaração perderá a sua validade.

(RC)

我们在此申明，依据产品的设计、结构以及由我们投放市场的款式，以下产品符合欧共体有关基本安全和健康的标准要求，包括电磁相容性准则、机器准则和低压准则。
如未经我们许可而对产品进行更改，则此申明失效。

Produkt
product
produit

produkt
producto
prodotto

produkt
produkt
Продукция

προϊόν
produto
产品

Comfort 220

Einschlägige EG-Richtlinien: EG-Richtlinie Elektromagnetische Verträglichkeit (89/336/EWG, 93/68/EWG und 93/44/EWG), Maschinen-Richtlinie (89/392/EWG, 91/368/EWG, 93/68/EWG und 93/44/EWG) und Niederspannungsrichtlinie (73/23/EWG, 93/68/EWG und 93/44/EWG).
Relevant European Council Directives pertaining to electromagnetic compatibility (89/336/EEC, 93/68/EEC and 93/44/EEC), machines (89/392/EEC, 91/368/EEC, 93/68/EEC and 93/44/EEC) and low voltage (73/23/EEC, 93/68/EEC and 93/44/EEC).
Directives CE se rapportant à la: Directive CE sur la compatibilité électromagnétique (89/336/CEE, 93/68/CEE et 93/44/CEE), de la directive concernant les machines (89/392/CEE, 91/368/CEE, 93/68/CEE et 93/44/CEE) et de celle relative à la basse tension (73/23/CEE, 93/68/CEE et 93/44/CEE).
Van toepassing zijnde Europese richtlijnen: EMC-richtlijn (89/336/EEG, 93/68/EEG en 93/44/EEG), Machine richtlijn (89/392/EEG, 91/368/EEG, 93/68/EEG en 93/44/EEG) en Laagspanningsrichtlijn (73/23/EEG, 93/68/EEG en 93/44/EEG).
Directivas de la CE obligatorias: Directiva CE sobre Compatibilidad electromagnética (89/336/MCE, 93/68/MCE y 93/44/MCE), la directiva de Maquinaria (89/392/MCE, 91/368/MCE, 93/68/MCE y 93/44/MCE) y la Directiva de Baja Tensión (73/23/MCE, 93/68/MCE y 93/44/MCE).
Direttive CE applicate: direttiva CE sulla compatibilità elettromagnetica (89/336/CEE, 93/68/CEE e 93/44/CEE), e direttiva relativa alle macchine (89/392/CEE, 91/368/CEE, 93/68/CEE e 93/44/CEE) e direttiva relativa alla bassa tensione (73/23/CEE, 93/68/CEE e 93/44/CEE).
Vedkommende EF-direktiver: EF-direktiv Elektromagnetisk kompatibilitet (89/336/EWG, 93/68/EWG og 93/44/EWG), Maskindirektivet (89/392/EWG, 91/368/EWG, 93/68/EWG og 93/44/EWG) og Lavspenningsdirektivet (73/23/EWG, 93/68/EWG og 93/44/EWG).
Relevante EF- direktiver: EF- Direktivet om Elektromagnetisk kompatibilitet (89/336/EØF, 93/68/EØF og 93/44/EØF), Maskindirektivet (89/392/EØF, 91/368/EØF, 93/68/EØF og 93/44/EØF) og Lavspændingsdirektivet (73/23/EØF, 93/68/EØF og 93/44/EØF).
Соответствующие директивы ЕС: директива ЕС по электромагнитной совместимости (89/336/EWG, 93/68/EWG и 93/44/EWG), директива по оборудованию (89/392/EWG, 91/368/EWG, 93/68/EWG и 93/44/EWG) и директива по технике низких напряжений (73/23/EWG, 93/68/EWG и 93/44/EWG).
Σχετικές Οδηγίες ΕΕ: Οδηγία ΕΕ ηλεκτρομαγνητικής συμβατότητας (89/336/ΕΟΚ, 93/68/ΕΟΚ και 93/44/ΕΟΚ), οι Οδηγίες μηχανημάτων (89/392/ΕΟΚ, 91/368/ΕΟΚ, 93/68/ΕΟΚ και 93/44/ΕΟΚ) και οι Οδηγίες χαμηλής τάσης (73/23/ΕΟΚ, 93/68/ΕΟΚ και 93/44/ΕΟΚ).
Directivas CE aplicáveis: Directiva CE relativa a Tolerância Electromagnética (89/336/EWG, 93/68/EWG e 93/44/EWG), Directiva relativa a Maquinaria (89/392/EWG, 91/368/EWG, 93/68/EWG e 93/44/EWG) e Directiva sobre Baixa Tensão (73/23/EWG, 93/68/EWG e 93/44/EWG).
有关欧共体准则：欧共体电磁兼容性准则（89/336/EWG, 93/68/EWG 和 93/44/EWG），机器准则（89/392/EWG, 91/368/EWG, 93/68/EWG 和 93/44/EWG）以及低压准则（73/23/EWG, 93/68/EWG 和 93/44/EWG）。

Angewandte harmonisierte Normen, insbesondere:

To agreed standards:

Normes harmonisées appliquées, tout spécialement:

Toegepaste geharmoniseerde normen, met name:

Normas armonizadas aplicadas, en especial:

Norme armonizzate applicate:

Benyttede harmoniserte normer, spesielt:

Anvendte harmoniserede standarder, især:

Соответствие единым стандартам, в частности:

Εφαρμοσθείσες εναρμονισμένες προδιαγραφές, ειδικότερα:

Normas harmonizadas aplicadas, sobretudo:

使用的统一标准，尤其包括：

EN 292-1
EN 50081-1
EN 50082-1
EN 55014
EN 61000-3-2
EN 61000-3-3
EN 60335-1
EN 60335-2-95
EN 12445
EN 12453
EN 300220-1
EN 301489-3
ETS 300683
I-ETS 300200

Angewandte nationale Normen und technische Spezifikationen, insbesondere:

To National standard and technical specification:

Normes nationales appliquées, et spécifications techniques, tout spécialement:

Toegepaste nationale normen en technische specificaties, met name:

Normas nacionales y especificaciones técnicas aplicadas, en especial:

Specificazioni tecniche a carattere nazionale applicate, in particolare:

Benyttede nasjonale normer og tekniske spesifikasjoner spesielt:

Anvendte nationale standarder og tekniske spesifikationer, især:

Соответствие национальным стандартам и техническим спецификациям, в частности:

Εφαρμοσθείσες εθνικές νόρμες και τεχνικές προδιαγραφές ειδικότερα:

Normas nacionais e especificações técnicas aplicadas, sobretudo:

使用的国家标准和技术规格，尤其包括：

ZH 494 April 89
VDE 0700-238

28.10.2002

ppa. Molterer

Datum/Unterschrift

Marantec

EG-Konformitätserklärung
EC Conformity Declaration
Déclaration CE de conformité
EG-conformiteitsverklaring
Declaración CE de conformidad
Dichiarazione CE di conformità

(D)

Hiermit erklären wir, daß das nachfolgend bezeichnete Produkt aufgrund seiner Konzipierung und Bauart sowie in der von uns in Verkehr gebrachten Ausführung den einschlägigen grundlegenden Sicherheits- und Gesundheitsanforderungen der EG-Richtlinie Elektromagnetische Verträglichkeit, der Maschinen-Richtlinie und der Niederspannungsrichtlinie entspricht.
Bei einer nicht mit uns abgestimmten Änderung der Produkte verliert diese Erklärung ihre Gültigkeit.

(GB)

We hereby declare that the product referred to below, with reference to its design, construction and to the version as marketed by us, conforms to the relevant safety and health requirements contained in the European Council Directives pertaining to electromagnetic compatibility, machines and low voltage.
This declaration becomes null and void in the event of modification or changes to the product not expressly agreed with us.

(F)

Par la présente, nous déclarons que le produit sous-mentionné correspond, de par sa conception et son type de construction, tout comme la version commercialisée, aux conditions fondamentales exigées pour la sécurité et la santé de la directive CE relative à la compatibilité électromagnétique, de la directive concernant les machines et de celle relative à la basse tension.
Cette déclaration perd toute validité en cas de modification des produits, effectuée sans notre accord.

(NL)

Hierbij verklaren wij dat het hierna genoemde product qua ontwerp en constructie alsmede de door ons op de markt gebrachte uitvoering voldoet aan de hiervoor geldende veiligheids- en gezondheidseisen conform de Europese richtlijnen t.w.: EMC-richtlijn, Machinerichtlijn en Laagspanningsrichtlijn.
Ingeval van wijzigingen aan onze producten die niet met ons afgestemd zijn, verliest deze verklaring haar geldigheid.

(E)

Por la presente declaramos que el producto indicado a continuación, en base a su concepción y tipo constructivo, así como en el acabado comercializado por nosotros, cumple con los requisitos básicos obligatorios sanitarios y de seguridad de la directiva de la CE sobre compatibilidad electromagnética, la Directiva de Maquinaria y la Directiva de Baja Tensión.
En caso de una modificación del producto no acordada con nosotros, esta declaración perderá su validez.

(I)

Con la presente dichiariamo che il prodotto di seguito descritto, in base alla sua progettazione e tipo e nella versione da noi messa in commercio, rispetta tutti i requisiti essenziali di sicurezza e sanitari che lo concernono previsti dalla direttiva CE sulla compatibilità elettromagnetica, dalla direttiva relativa alle macchine e dalla direttiva relativa alla bassa tensione.
In caso di modifica apportata senza nostra autorizzazione, la presente dichiarazione perde la propria validità.

EF-konformitetserklæring
EU-overensstemmelseserklæring
Заявление о соответствии директивам ЕС
ΕΟΚική δήλωση εναρμόνισης
Declaração CE de Conformidade
欧共体符合标志申明

(N)

Herved erklærer vi at det i det følgende betegnede produktet på grunn av dets konsepsjon og konstruksjon i den versjonen som vi har brakt i handelen er i samsvar med de vedkommende grunnleggende krav til sikkerhet og helse i EF-direktivet Elektromagnetisk kompatibilitet, i Maskindirektivet og i Lavspenningsdirektivet.
Ved en endring av produktet som ikke er avstemt med oss, mister denne erklæringen sin gyldighet.

(DK)

Hermed erklærer vi, at efterfølgende opførte produkt på grund af dets concipering og konstruktion og i den udførelse, som vi har bragt i handelen, opfylder de vedtagne grundlæggende sikkerheds- og sundhedskrav ifølge EF-Direktivet om Elektro-magnetisk kompatibilitet, Maskindirektivet og Lavspændingsdirektivet.
Såfremt der foretages ændringer af produktet, der ikke er godkendt af os, bliver nærværende erklæring ugyldig.

(RUS)

настоящим объявляем, что указанная ниже продукция по своему проектированию и конструкции, а также по используемому нами типу изготовления соответствует действующим основополагающим требованиям по безопасности и охране здоровья директив ЕС по электромагнитной совместимости, оборудованию и технике низких напряжений. В случае производства несанкционированных производителем изменений в продукции, данная декларация считается недействительной.

(GR)

Με την παρούσα δηλώνουμε ότι το προϊόν που περιγράφεται παρακάτω, σύμφωνα με το σχεδιασμό και τον τύπο κατασκευής του, στο μοντέλο που κυκλοφορεί στο εμπόριο, πληρεί όλες τις βασικές απαιτήσεις ασφαλείας και υγιεινής που προβλέπουν η Οδηγία ΕΕ σχετικά με την ηλεκτρομαγνητική συμβατότητα, η αντίστοιχη Οδηγία μηχανημάτων και η Οδηγία χαμηλής τάσης. Σε περίπτωση τροποποίησης χωρίς την έγκρισή μας, η παρούσα δήλωση παύει να ισχύει.

(P)

Declaramos por este meio que o produto abaixo descrito corresponde, pela sua concepção e modelo, tal como no modelo por nós comercializado, às respectivas exigências básicas de segurança e de saúde da Directiva CE relativa a Tolerância Electromagnética, da Directiva relativa a Maquinaria e da Directiva sobre Baixa Tensão.
Em caso de qualquer tipo de alteração não previamente acordada com a nossa Empresa, a presente declaração perderá a sua validade.

(RC)

我们在此申明，依据产品的设计、结构以及由我们投放市场的款式，以下产品符合欧共体有关基本安全和健康的准则要求，包括电磁相容性准则、机器准则和低压准则。
如未经我们许可而对产品进行更改，则此申明失效。

Produkt product produit	produkt producto prodotto	produkt produkt Продукция	προϊόν producto produto
-------------------------------	---------------------------------	---------------------------------	-------------------------------

Einschlägige EG-Richtlinien: EG-Richtlinie Elektromagnetische Verträglichkeit (89/336/EWG, 93/68/EWG und 93/44/EWG), Maschinen-Richtlinie (89/392/EWG, 91/368/EWG, 93/68/EWG und 93/44/EWG) und Niederspannungsrichtlinie (73/23/EWG, 93/68/EWG und 93/44/EWG).
 Relevant European Council Directives pertaining to electromagnetic compatibility (89/336/EEC, 93/68/EEC and 93/44/EEC), machines (89/392/EEC, 91/368/EEC, 93/68/EEC and 93/44/EEC) and low voltage (73/23/EEC, 93/68/EEC and 93/44/EEC).
 Directives CE se rapportant à la: Directive CE sur la compatibilité électromagnétique (89/336/CEE, 93/68/CEE et 93/44/CEE), de la directive concernant les machines (89/392/CEE, 91/368/CEE, 93/68/CEE et 93/44/CEE) et de celle relative à la basse tension (73/23/CEE, 93/68/CEE et 93/44/CEE).
 Van toepassing zijnde Europese richtlijnen: EMC-richtlijn (89/336/EEG, 93/68/EEG en 93/44/EEG), Machine richtlijn (89/392/EEG, 91/368/EEG, 93/68/EEG en 93/44/EEG) en Laagspanningsrichtlijn (73/23/EEG, 93/68/EEG en 93/44/EEG).
 Directivas de la CE obligatorias: Directiva CE sobre Compatibilidad electromagnética (89/336/MCE, 93/68/MCE y 93/44/MCE), la directiva de Maquinaria (89/392/MCE, 91/368/MCE, 93/68/MCE y 93/44/MCE) y la Directiva de Baja Tensión (73/23/MCE, 93/68/MCE y 93/44/MCE).
 Direttive CE applicate: direttiva CE sulla compatibilità elettromagnetica (89/336/CEE, 93/68/CEE e 93/44/CEE), direttiva relativa alle macchine (89/392/CEE, 91/368/CEE, 93/68/CEE e 93/44/CEE) e direttiva relativa alla bassa tensione (73/23/CEE, 93/68/CEE e 93/44/CEE).
 Vedkommende EF-direktiver: EF-direktiv Elektromagnetisk kompatibilitet (89/336/EWG, 93/68/EWG og 93/44/EWG), Maskindirektivet (89/392/EWG, 91/368/EWG, 93/68/EWG og 93/44/EWG) og Lavspenningsdirektivet (73/23/EWG, 93/68/EWG og 93/44/EWG).
 Relevante EF- direktiver: EF- Direktivet om Elektromagnetisk kompatibilitet (89/336/EØF, 93/68/EØF og 93/44/EØF), Maskindirektivet (89/392/EØF, 91/368/EØF, 93/68/EØF og 93/44/EØF) og Lavspændingsdirektivet (73/23/EØF, 93/68/EØF og 93/44/EØF).
 Соответствующие директивы ЕС: директива ЕС по электромагнитной совместимости (89/336/EWG, 93/68/EWG и 93/44/EWG), директива по оборудованию (89/392/EWG, 91/368/EWG, 93/68/EWG и 93/44/EWG) и директива по технике низких напряжений (73/23/EWG, 93/68/EWG и 93/44/EWG).
 Σχετικές Οδηγίες ΕΕ: Οδηγία ΕΕ ηλεκτρομαγνητικής συμβατότητας (89/336/ΕΟΚ, 93/68/ΕΟΚ και 93/44/ΕΟΚ), οι Οδηγίες μηχανημάτων (89/392/ΕΟΚ, 91/368/ΕΟΚ, 93/68/ΕΟΚ και 93/44/ΕΟΚ) και οι Οδηγίες χαμηλής τάσης (73/23/ΕΟΚ, 93/68/ΕΟΚ και 93/44/ΕΟΚ).
 Directivas CE aplicáveis: Directiva CE relativa a Tolerância Electromagnética (89/336/EWG, 93/68/EWG e 93/44/EWG), Directiva relativa a Maquinaria (89/392/EWG, 91/368/EWG, 93/68/EWG e 93/44/EWG) e Directiva sobre Baixa Tensão (73/23/EWG, 93/68/EWG e 93/44/EWG).
 有关欧共体准则：欧共体电磁兼容性准则（89/336/EWG, 93/68/EWG 和 93/44/EWG），机器准则（89/392/EWG, 91/368/EWG, 93/68/EWG 和 93/44/EWG）以及低压准则（73/23/EWG, 93/68/EWG 和 93/44/EWG）。

Angewandte harmonisierte Normen, insbesondere:

To agreed standards:

Normes harmonisées appliquées, tout spécialement:

Toegepaste geharmoniseerde normen, met name:

Normas armonizadas aplicadas, en especial:

Norme armonizzate applicate:

Benyttede harmoniserede normer, spesielt:

Anvendte harmoniserede standarder, især:

Соответствие единым стандартам, в частности:

Εφαρμοσθείσες εναρμονισμένες προδιαγραφές, ειδικότερα:

Normas harmonizadas aplicadas, sobretudo:

使用的统一标准，尤其包括：

EN 292-1
 EN 50081-1
 EN 50082-1
 EN 55014
 EN 61000-3-2
 EN 61000-3-3
 EN 60335-1
 EN 60335-2-95
 EN 12445
 EN 12453
 EN 300220-1
 EN 301489-3
 ETS 300683
 I-ETS 300200

Angewandte nationale Normen und technische Spezifikationen, insbesondere:

To National standard and technical specification:

Normes nationales appliquées, et spécifications techniques, tout spécialement:

Toegepaste nationale normen en technische specificaties, met name:

Normas nacionales y especificaciones técnicas aplicadas, en especial:

Specificazioni tecniche a carattere nazionale applicate, in particolare:

Benyttede nasjonale normer og tekniske spesifikasjoner spesielt:

Anvendte nationale standarder og tekniske spesifikasjoner, især:

Соответствие национальным стандартам и техническим спецификациям, в частности:

Εφαρμοσθείσες εθνικές νόρμες και τεχνικές προδιαγραφές ειδικότερα:

Normas nacionais e especificações técnicas aplicadas, sobretudo:

使用的国家标准和技术规格，尤其包括：

ZH 494 April 89
 VDE 0700-238

Datum/Unterschrift





ENGLISH

Copyright.

No part of this manual may be reproduced without our prior approval.

Subject to alterations in the interests of technical progress.

